

Description



IP POWER

MODEL : PS2308



8-Port Power Distribution Unit-230V

Made in Taiwan

The PDU is an Internet ready device designed and is equipped with an intelligent currentmeter (True RMS) that will indicate the total power consumption of a power strip. The PDU offers an easy set up and user-friendly communication software. This software provides the function that assistant manager to remotely monitor the multiple PDU power consumption to realize the total current power consumption and utilization for the enterprises.

Features

Diagram

- Built-in web server, manager can real time to monitoring the current consumption of the power strip.
- Build-in true RMS current meter.
- Setup easily, meter can read the IP address directly.
- Homepage support SSL.
- Provide audible alarm when the power consumption over the threshold of warning and overload.
- Send the email and traps when the power consumption exceed the trigger value of warning or overload to the PDU.
- Provide utility, it can monitor a large mount of PDU at the same time.
- Support the SNMP and provide MIB for the PDU to be monitored by NMS.
- Provide per outlet power protection by the circuit breaker.
- Real time to control outlets of PDU.
- Indicate outlets status with LED.
- Support power on sequence.
- Option accessory can support temperature and humidity detection.

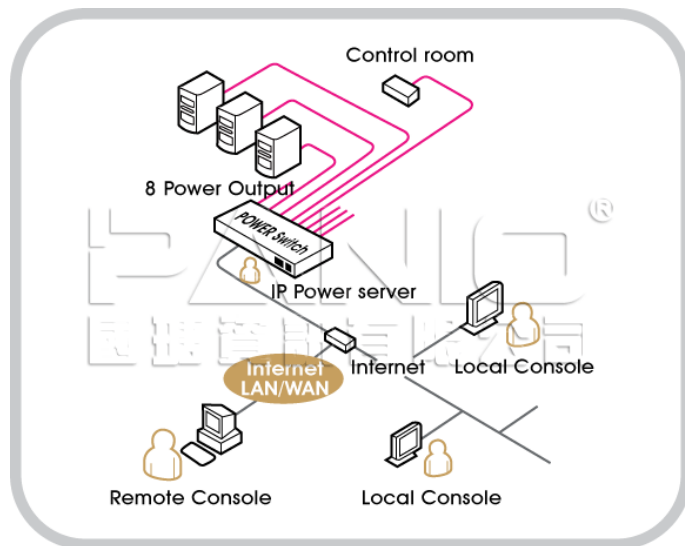

Accessories :

- 1 x PS2308 Power Distribution Unit.
- 1 x CD-ROM, it contains:
- 1 x Power Cord
- 1 x Rack mount Brackets.